

V 120 SG - V 160 SG

Instructions for use

Get to know your wine cooler:

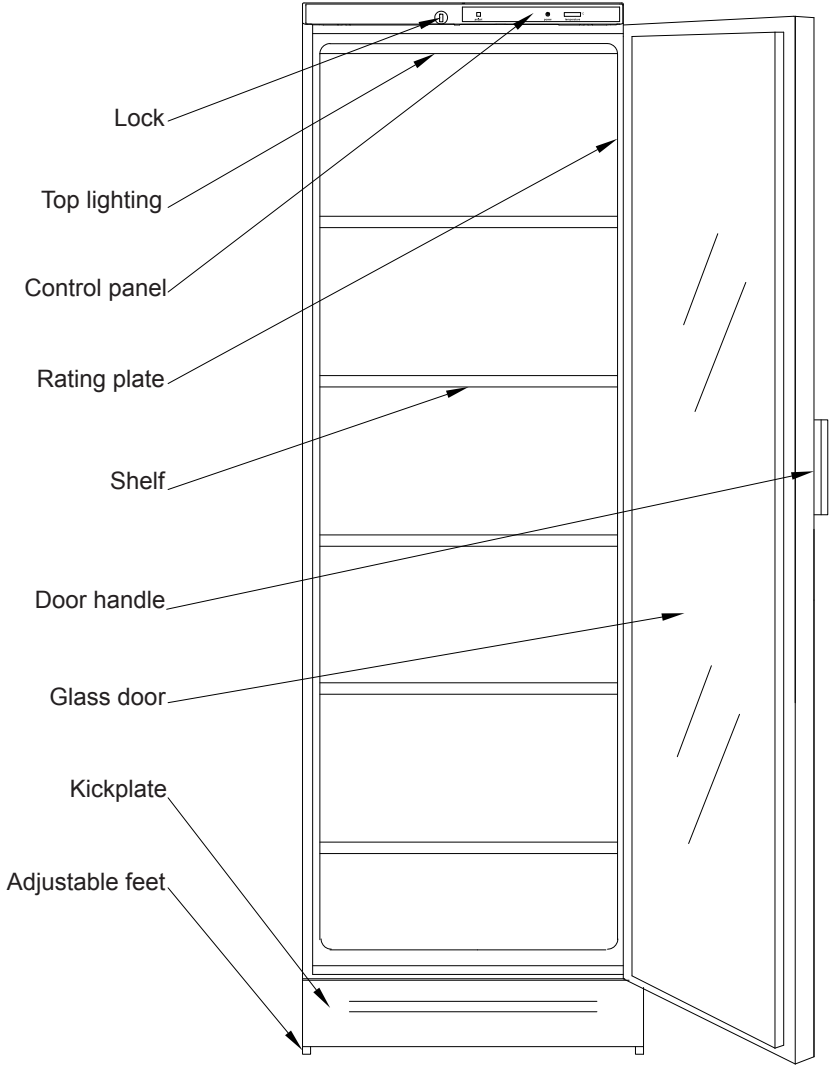

Warning.

In case this appliance contains hydrocarbon refrigerant please refer to guidelines listed below.

As the appliance contains a flammable refrigerant, it is essential to ensure that the refrigerant pipes are not damaged.

Standard EN378 specifies that the room in which you install your appliance must have a volume of 1m³ per 8 g of hydrocarbon refrigerant used in the appliances. This is to avoid the formation of flammable gas/air mixtures in the room where the appliance is located in the event of a leak in the refrigerant circuit. The quantity of the refrigerant used in your appliance is indicated on the rating plate.

WARNING: Keep ventilation openings in the appliance's cabinet or in the built-in structure clear of obstruction

WARNING: Do not use other **mechanical devices** or other means to accelerate the defrosting process than those recommended by the manufacturer

WARNING: Do not damage the refrigerant system

WARNING: Do not use **electrical appliances** inside the refrigerated storage compartment, unless they are of a type recommended by the manufacturer

WARNING: Do not expose the appliance to rain

WARNING: This appliance is not intended for use by young children or infirm persons unless they have been adequately supervised by

a responsible person to ensure that they can use the appliance safely. Young children should be supervised to ensure that they do not play with the appliance

- Always keep the keys in a separate place and out of reach of children
- Before servicing or cleaning the appliance, unplug the appliance from the mains or disconnect the electrical power supply
- If the supply cord is damaged, it must be replaced by the manufacturer, its service agent, or similarly qualified persons in order to avoid a hazard
- **Relevant for Australia:** Supply cord fitted with a plug complies with AS/NZS 3112.
- Frost formation on the interior evaporator wall and upper parts is a natural phenomenon. Therefore, the appliance should be defrosted during normal cleaning or maintenance
- Directions for replacing the illuminating lamps are to be included in the instruction
- Please note that changes to the appliance construction will cancel all warranty and product liability
- This appliance is intended to be used exclusively for the storage of wine

CLASS 1 LED PRODUCT



Contents

Get to know your wine cooler	2
Warning	3
Before starting the appliance.....	4
Maintenance.....	4
Has the appliance stopped working?.....	5
Technical data.....	5
Installation	5
Control panel	6
Reversing the door	7
Replaceable lamp strip.....	9
Ajustment of the door	9
Mounting of lock.	9
Warranty and spare parts	10
Disposal.....	11

Before starting the appliance

Check that the cabinet is undamaged. Please report any damage immediately to your dealer. Wash the cabinet and inner lining with a mild unscented detergent and wipe it dry. Do not use abrasive scouring powder, steel wool or similar.

Maintenance

Only use an unscented detergent when cleaning the cabinet inside.

You may remove the top panel and wash it when cleaning the cabinet inside.

Switch off the appliance and pull out the plug when cleaning the cabinet.

The skirting board can be removed to facilitate a vacuum-cleaning of the floor.

To make the cooling system work at its optimum it is necessary from time to time to clean the wire condensator and the compressor at the back of the cabinet by means of a brush or a vacuum cleaner. Remember to clean the drain.

Has the appliance stopped working?

Before calling a repairman, check that

- The plug is properly plugged into the wall socket.
- The fuse is intact.
- The power has not been cut off.
- All controls are correctly set.
- Switch off the cabinet for 15 minutes (for instance at the thermostat). Switch it on again and after 5 minutes check whether frost has formed on the evaporator.
- Do not open the cabinet when unnecessary.

Technical data.

This device complies with relevant EU directives including Low Voltage Directive 2006/95 EEC. and Electromagnetic Compatibility Directive 2004/108/EC

The rating plate provides various technical information as well as type and serial number.

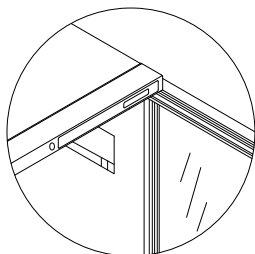

Installation.

See drawings - page A and B.

Install the cabinet in a dry place and so that it is not exposed to direct sunlight or any other source of heat.

Place the cabinet in a level position. This is easily achieved by adjusting the adjustable feet at the front edge of the base.

The cabinet may not rest against a wall on its hinged side. When placing the cabinet on a carpet or on a wooden floor you should adjust it once more after some time as the cabinet might settle in soft foundations.

If you want to build the appliance into a cupboard you must consider 3 factors:

1. There must be space above the appliance in order to make the cooling system work satisfactorily.
2. When the door is opened the appliance takes up more room in the width and therefore the door must either be placed outside the cupboard or there must be a space of at least 1,5 cm at the hinge side.
3. The distance to the wall at the hinge side must be of a sufficient size.

Furthermore is it possible to build together the appliance and another cabinet.

It is safest to place the earthed wall socket above the appliance and at least 1.7 / 2.0 m above the floor. Any local installation rules for appliances of this kind must be observed.

During a storm the electricity supply might be cut off.

You should be aware of this when installing the appliance in weekend cottages or else-

where where you would not immediately observe that the power has been cut off. Construction and details in the accessories are subject to alteration without previous notice.

Control panel.

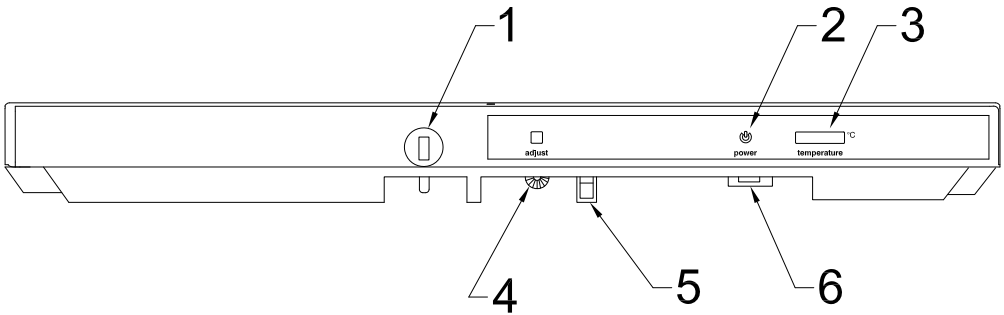

Connect the appliance to the socket outlet. A green light indicates that the appliance has been switched on.

The thermostat knob is adjustable from 0 (stop) to 7 (coldest). Find the position of the thermostat which gives you the desired temperature. Start at position 4.

1. Lock
2. Green light indicating power on
3. Thermometer
4. Thermostat button.
5. Door switch for internal fan
6. Light switch

The switch (6) on the top right of the control panel is for turning the top lighting on and off.

Reversing the door.

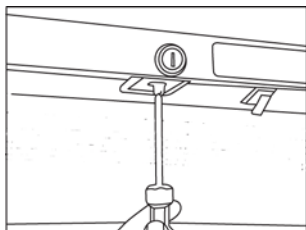

1. Remove the lock pin using a flat-headed screwdriver.

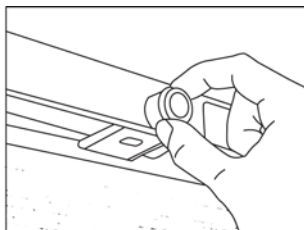

2. Remove the lock housing.

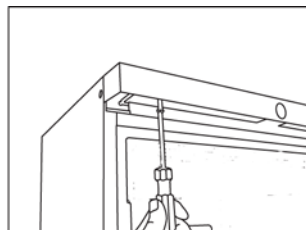

3. Loosen the top panel. Do not remove the screws, just loosen them.

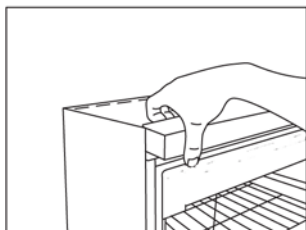

4. Tilt the top panel forwards to remove it (it is secured in three places)

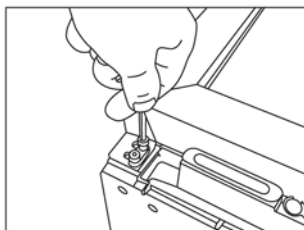

5. Lay the appliance on its back and remove the upper hinge, using the hex key.

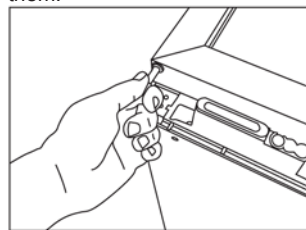

6. Pull the torsion spring out of the door together with the hinge.

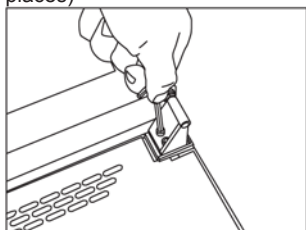

7. Remove the bottom hinge using the hex key.

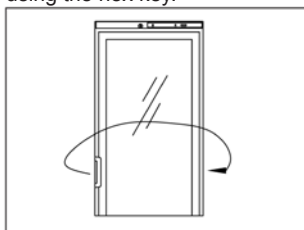

8. Move the door handle to the opposite side.

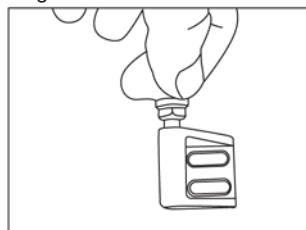

9. Move the hinge pin to the opposite side of the bottom hinge.



10. Refit the bottom hinge on the opposite side.

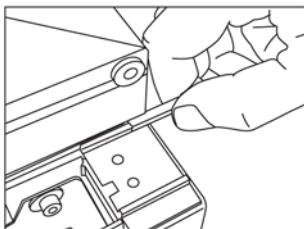

11. Move the plastic door guard to the opposite side.

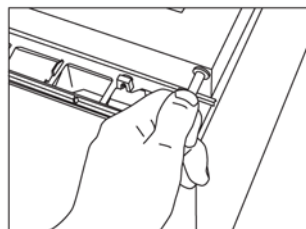

12. Insert the hinge pin and torsion spring into the top of the door on the opposite side.

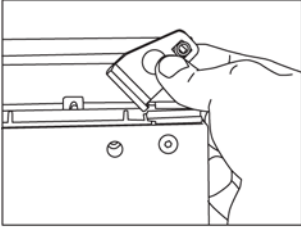

13. Fit the left-side top hinge (available as extra). Tighten the torsion spring approx. 1/2 turn (anticlockwise on left side, clockwise on right.)

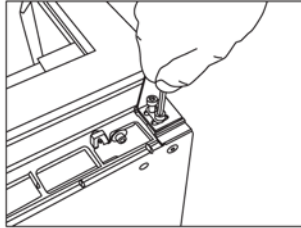

14. Secure the top hinge in position.

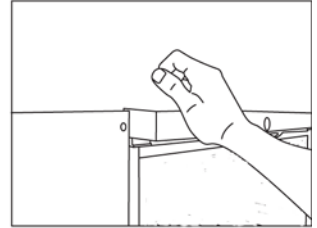

15. Raise the appliance into upright position. Click the top panel into place (it is secured in three places.)

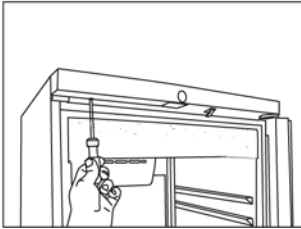

16. Retighten the top panel screws using a screwdriver.

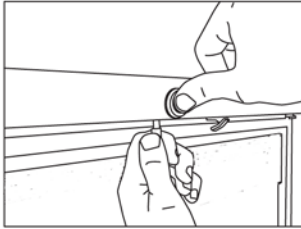

17. Refit the lock housing and lock pin.

18. After reversing the door, it is important to check that the sealing strip provides a tight seal all the way round. If it does not, carefully heat the strip all the way round using a hair dryer. Then ease the strip outwards slightly so that it forms a tight seal against the cabinet. Be careful not to heat the strip so much that it melts!

Shelf.

Max. 85 kg.

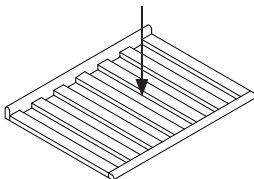

Replaceable lamp strip.

- Pull the screen to the left.
- Pull down the right side of the screen and take it out.

Remove the strip - possibly with text - by pulling it out of the tracks along the whole length of the profile.

The mounting is performed in reverse order.

Adjustment of the door.

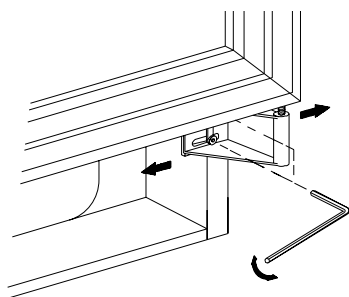

Mounting of lock for appliance with 1 door.

(Optional extra.)

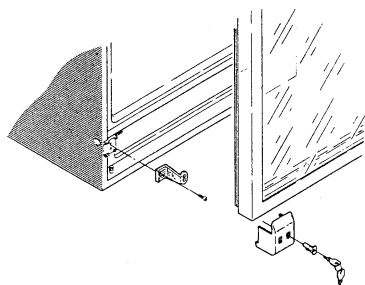

Warranty, spare parts and service.

Warranty disclaimer

Faults and damage caused directly or indirectly by incorrect operation, misuse, insufficient maintenance, incorrect building, installation or mains connection. Fire, accident, lightning, voltage variation or other electrical interference, including defective fuses or faults in mains installations.

Repairs performed by others than approved service centres and any other faults and damage that the manufacturer can substantiate are caused by reasons other than manufacturing or material faults are not covered by the warranty.

Please note that changes to the construction of the appliance or changes to the component equipment of the appliance will invalidate warranty and product liability, and the appliance cannot be used lawfully. The approval stated on rating plate will also be invalidated.

Transport damage discovered by the buyer is primarily a matter to be settled between the buyer and the distributor, i.e. the distributor must ensure that such complaints are resolved to the buyer's satisfaction.

Before calling for technical assistance, please check whether you are able to rectify the fault yourself. If your request for assistance is unwarranted, e.g. if the appliance has failed as a result of a blown fuse or incorrect operation, you will be charged the costs incurred by your call for technical assistance.

Spare parts

When ordering spare parts, please state the type, serial and product numbers of your appliance. This information is given on the rating plate. The rating plate contains various technical information, including type and serial numbers.

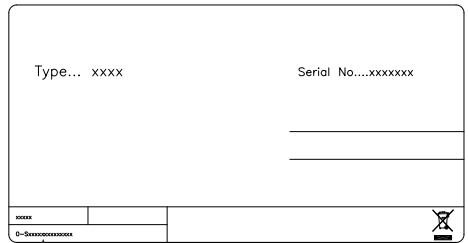

Disposal

Information for Users on Collection and Disposal of Old Equipment and used Batteries



These symbols on the products, packaging, and/or accompanying documents mean that used electrical and electronic products and batteries should not be mixed with general household waste. For proper treatment, recovery and recycling of old products and used batteries, please take them to applicable collection points, in accordance with your national legislation and the Directives 2002/96/EC and 2006/66/EC.

By disposing of these products and batteries correctly, you will help to save valuable resources and prevent any potential negative effects on human health and the environment which could otherwise arise from inappropriate waste handling.

For more information about collection and recycling of old products and batteries, please contact your local municipality, your waste disposal service or the point of sale where you purchased the items.

Penalties may be applicable for incorrect disposal of this waste, in accordance with national legislation.



For business users in the European Union.

If you wish to discard electrical and electronic equipment, please contact your dealer or supplier for further information.

[Information on Disposal in other Countries outside the European Union]

These symbols are only valid in the European Union. If you wish to discard this product, please contact your local authorities or dealer and ask for the correct method of disposal.

Note for the battery symbol (bottom two symbol examples):



This symbol might be used in combination with a chemical symbol. In this case it complies with the requirement set by the Directive for the chemical involved.

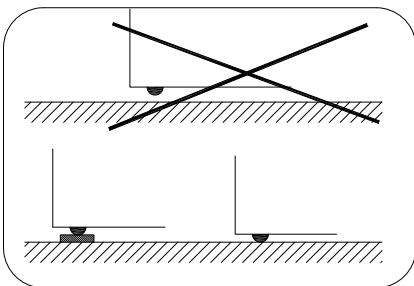
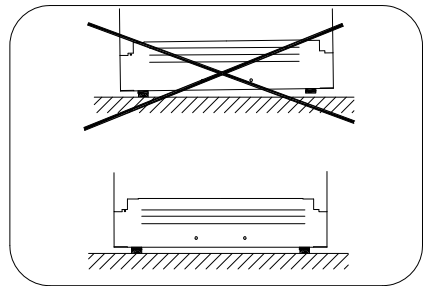
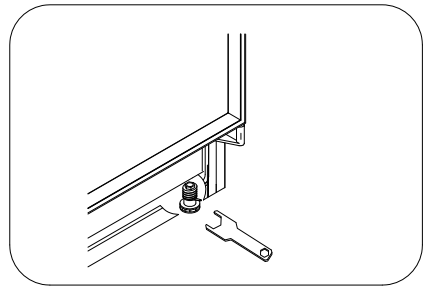
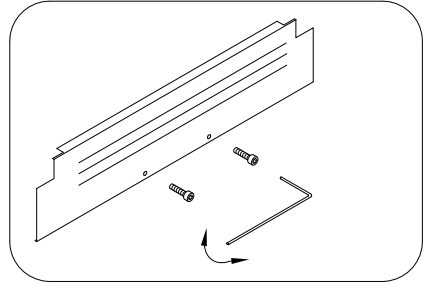
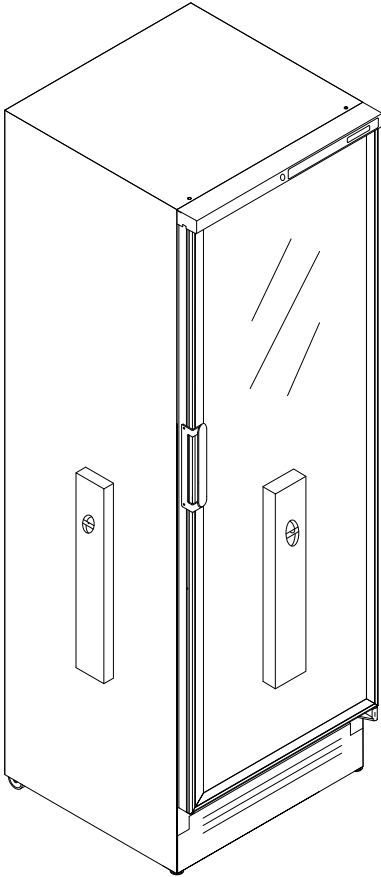

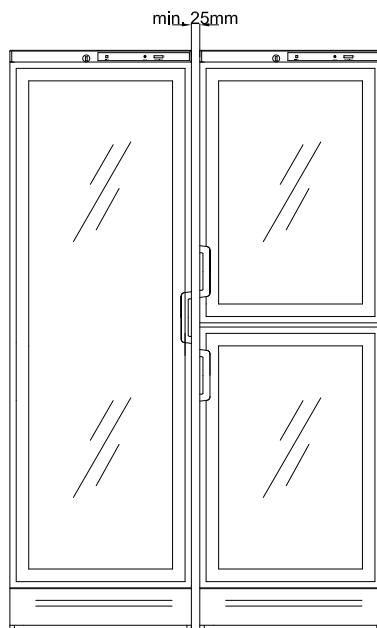
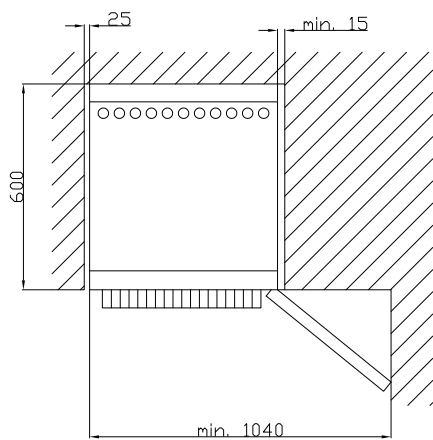
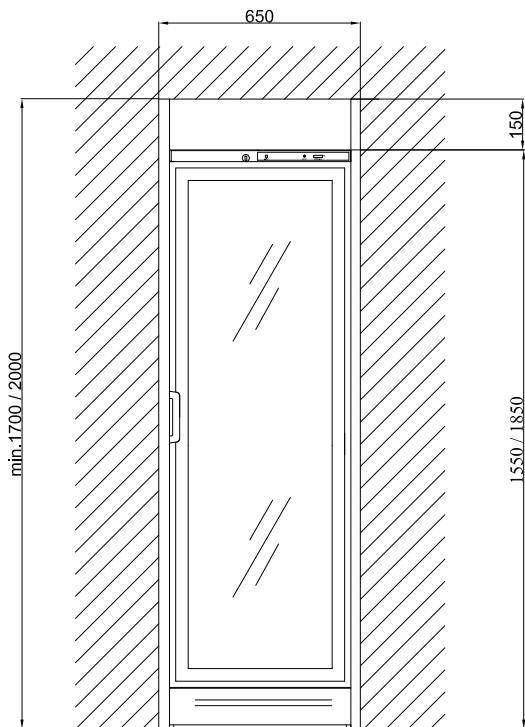

Reserves the right to alter specifications without prior notice.

91.93.149-03